

# POWER SYSTEMS

Industrial Solutions Full Line



**KOHLER**<sup>®</sup>  
IN POWER. SINCE 1920.



**KOHLER®**

KOHLERPower.com

## TABLE OF CONTENTS

Total System Integration	6
Diesel Generators	8
Gas Generators	14
Fast-Response Alternators	18
Controls	20
Enclosures	24
Sub-Base Fuel Tanks	26
Mobile Generators	28
Automatic Transfer Switches	34
Paralleling Switchgear	38
Decision-Maker® Paralleling System	40
Power Solutions Center	42
Kohler Genuine Parts	44
Service and Support	46

We're nearly 100 and only getting better with age. For the last century, we've forged the future, redefining what power means to people's lives, careers and lifestyles.

**POWER IS W**

**192**

# WHY SINCE WHAT WE DO.

## **SO WHY KOHLER?**

**We're a company of fearless thinkers driven to empower people all over the world — with reliable, revolutionary engines, generators and power systems.**

**We exist for one reason:  
*TO MOVE YOU FORWARD.***



# **TOTAL SYSTEM INTEGRATION**

## **Everything works together. Just as it should.**

A power system is only as good as the parts that define it.  
That's why we engineer every detail down to the last bolt.  
From generators and transfer switches to paralleling switchgear  
and controllers, everything works together seamlessly.  
Because we designed, engineered and tested it that way.

That's the Kohler difference.



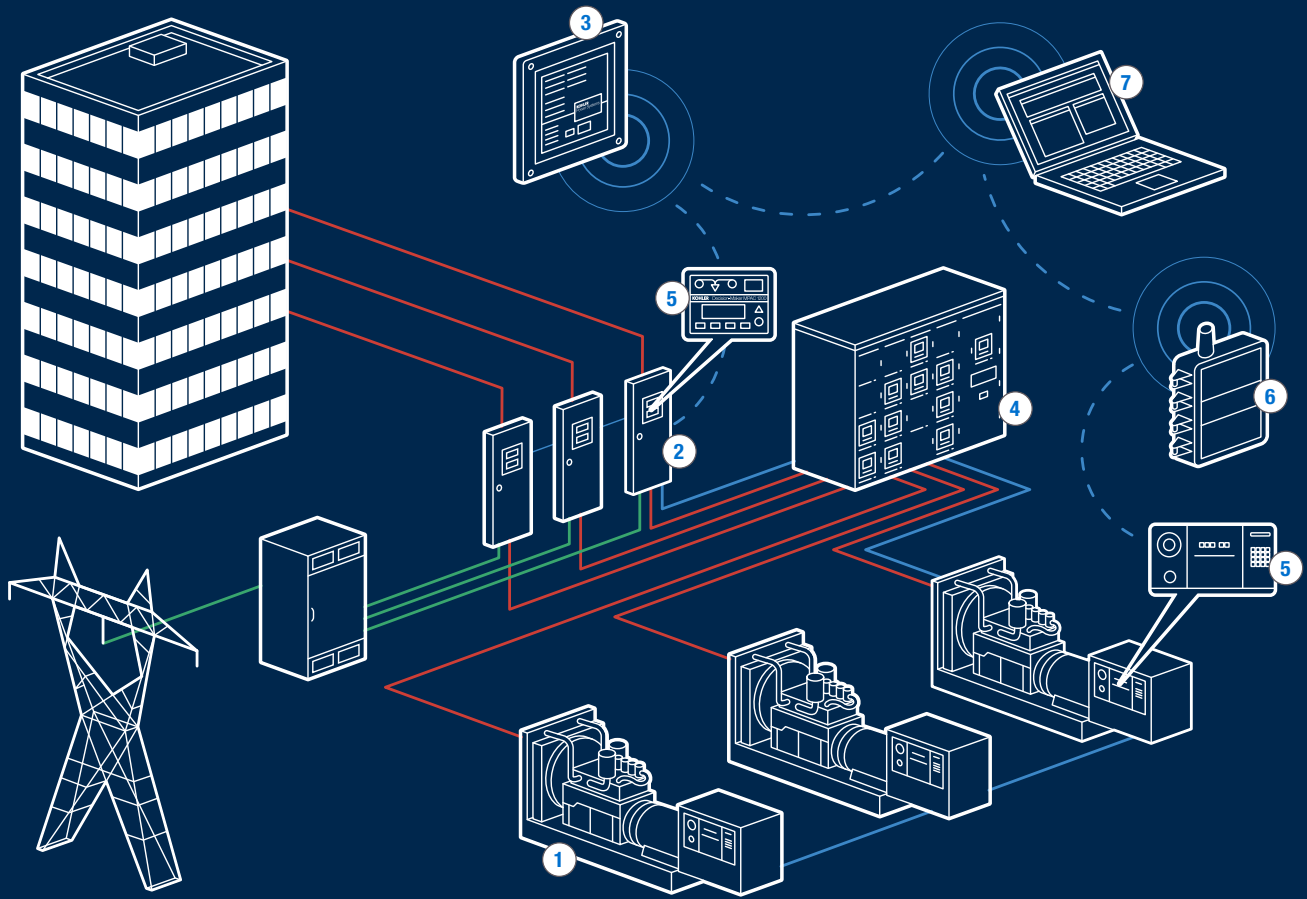

## TOTAL SYSTEM INTEGRATION

1. **KOHLER® GENERATOR**  
Gas generators 40-1300 kW  
Diesel generators 15-4000 kW
2. **KOHLER AUTOMATIC TRANSFER SWITCH**  
Open, closed and programmed transition operating modes; standard, bypass-isolation and service-entrance switch configurations
3. **KOHLER REMOTE ANNUNCIATOR**  
Remote monitoring and testing of transfer switches
4. **KOHLER PARALLELING SWITCHGEAR**  
Low and medium voltage
5. **KOHLER DECISION-MAKER® CONTROLLER**  
Controls, monitors and aids system diagnostics
6. **KOHLER WIRELESS MONITOR**  
Performance monitoring around-the-clock
7. **KOHLER MONITORING SOFTWARE**  
Monitors generators and transfer switches from a PC



# DIESEL GENERATORS

Built for the most critical jobs on earth.

15–4000 kW

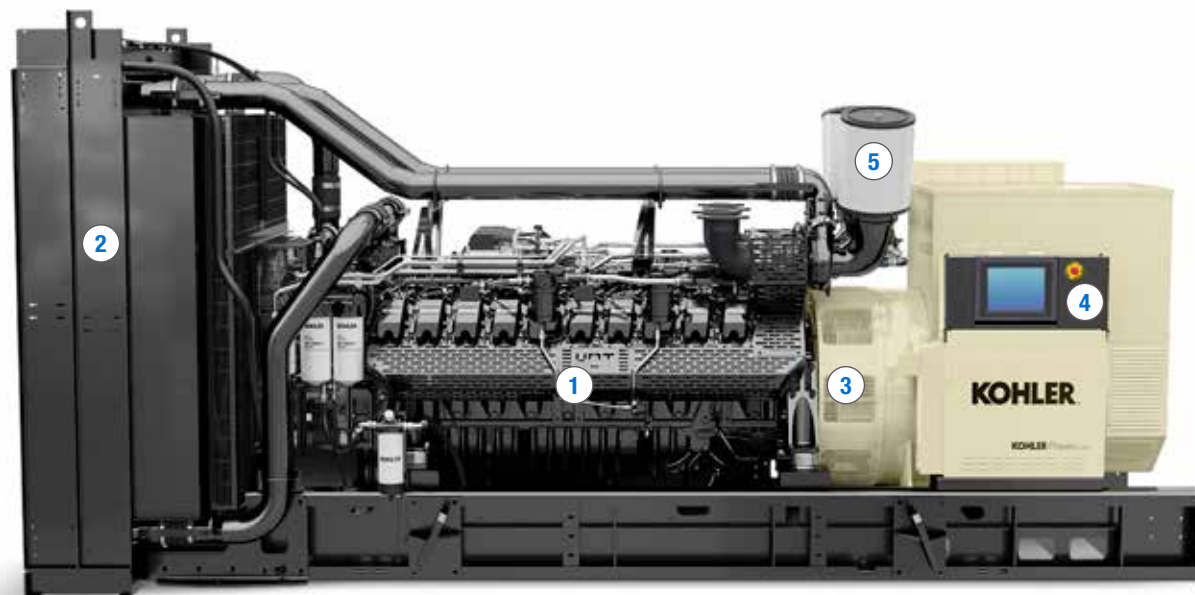

*KD1750*

Think about the most important places in the world: hospitals, airports, data centers, water treatment plants, etc. Those are the places we protect. The ones that absolutely have to have power—no matter what.

And with diesel generators ranging from 15 to 4000 kW, there's no job too small, no building too big. KOHLER® diesel generators are available EPA-certified. And you can customize them any way you like with a variety of accessories.

- 1. EMISSION-CERTIFIED**  
*EPA-certified, industrial-grade engines meet the latest emissions requirements*
- 2. HIGH-AMBIENT COOLING**  
*Designed to meet extreme operating conditions*
- 3. KOHLER PMG ALTERNATORS**  
*Provide advanced short-circuit capability and meet NEMA MG 1, IEEE and ANSI standards*
- 4. KOHLER DECISION-MAKER® CONTROLS**  
*Available with a variety of controls—basic, advanced and paralleling*
- 5. OPTIONS AND ACCESSORIES**  
*Improved motor-starting alternators, heavy-duty air cleaners, enclosures, fuel tanks, block heaters, multiple circuit breakers and more*





30REOZK



500REOZJB



KD2500

## STANDARD FEATURES

### Tested and Approved

KOHLER® generators meet tough industry testing and quality standards (UL, CSA, IBC, NFPA).

### Rapid Response

Our generators power up in 10 seconds or less and deliver quality power during voltage and frequency changes.

### Easy Installation

Our quickest install ever—large stub-up areas; easy access to fuel, load and exhaust locations.

# DIESEL GENERATORS

## KD SERIES™ GENERATORS

Welcome to an entirely new generator experience. The next leap forward in industrial power. With almost a century of engineering know-how behind them, our new class of KD Series generators are built with an eye on the future—designed to last for decades, with better fuel economy and a smaller footprint than ever before.

### Revolutionary, Reliable Engines

We engineer, test and fit every single component. And our computer-aided quality-management system oversees every step of development, from the first stage of production through the engine's entire lifecycle, to ensure the highest level of quality.

### Fuel-Efficient

Our G-Drive engine common rail fuel system generates up to 2200-bar injection pressures for maximum efficiency, optimizing the combustion pressure curve through multiple injections. This produces industry-leading power output in a package that enables a smaller generator set footprint while delivering best-in-class\* fuel consumption.

### Common Service Part Numbers

KOHLER G-Drive engines feature a modular system that allows us to scale the number of components depending on the power required. Using standard components means fewer parts to be stocked in the field and less time training operators. All of which reduce cost and improve response time.

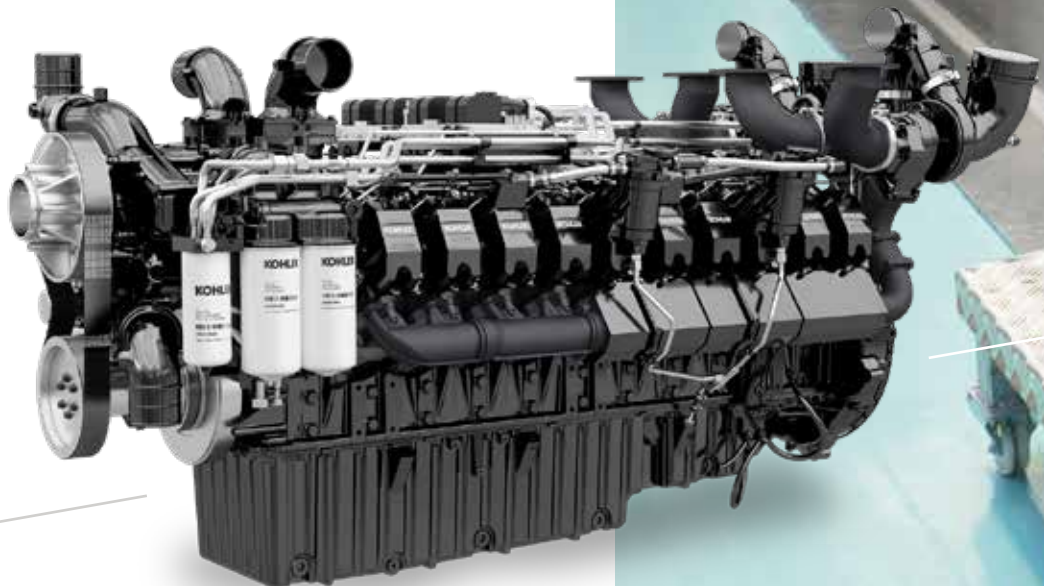



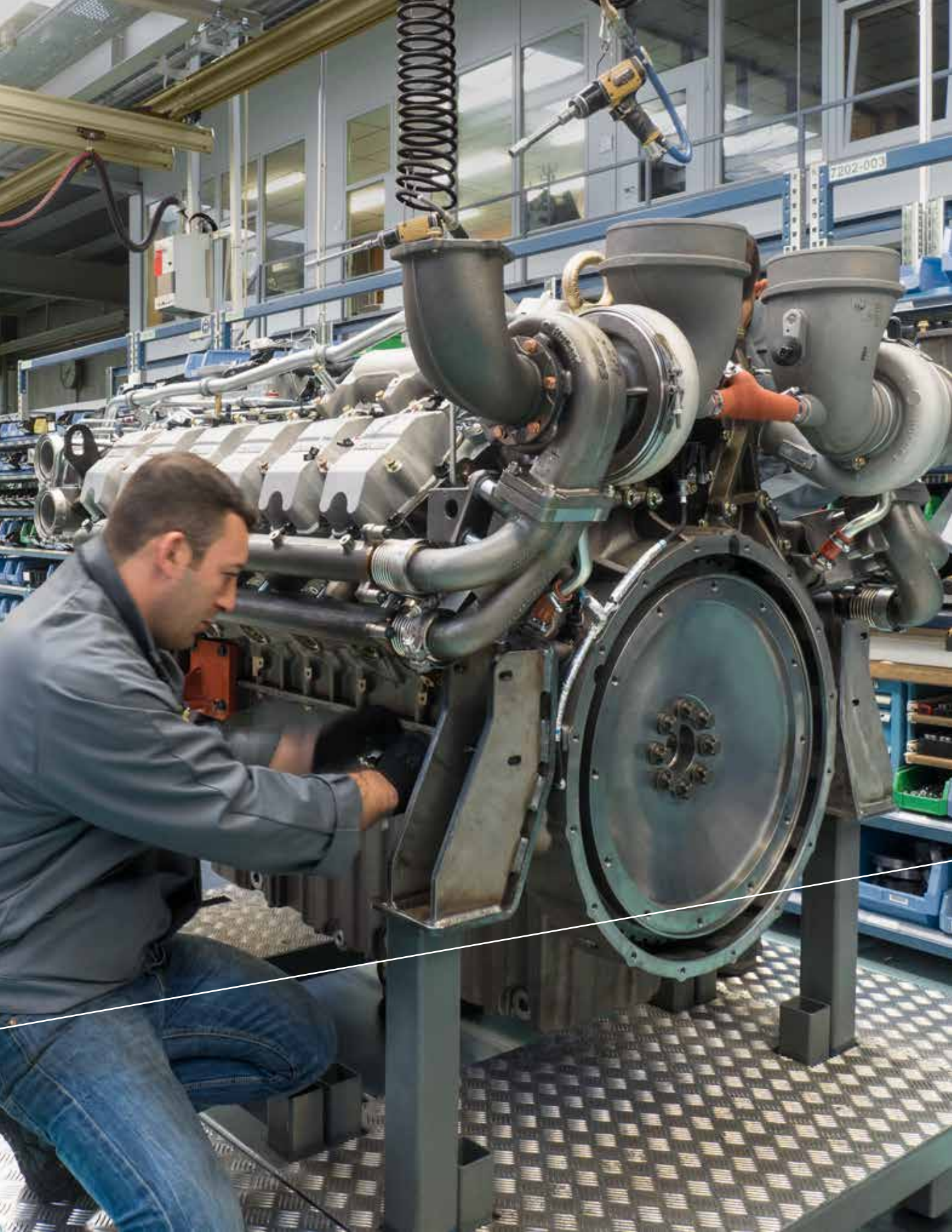

# DIESEL GENERATORS

MODEL	STANDBY 60 Hz (kW/kVA)	PRIME 60 Hz (kW/kVA)	RPM	Engine Manufacturer	EPA Emissions
15REOZK	17/21.3	15/18.8	1800	Kohler	EPA-certified
20REOZK	24/30	21/26.3	1800	Kohler	EPA-certified
30REOZK	31/39	28/25	1800	Kohler	EPA-certified
30REOZK4	30/37.5	28/35	1800	Kohler	Tier 4
40REOZK	42/52	37/46	1800	Kohler	Tier 3
40REOZK4	40/50	36/45	1800	Kohler	Tier 4
48REOZK4	48/60	43/53	1800	Kohler	Tier 4
50REOZK	52/65	47/58	1800	Kohler	Tier 3
60REOZK	60/75	54/67	1800	Kohler	Tier 3
80REOZJF	83/104	76/95	1800	John Deere	Tier 3
80REOZJ4	85/106	76/95	1800	John Deere	Tier 4
100REOZJF	102/128	92/115	1800	John Deere	Tier 3
100REOZJ4	105/131	96/120	1800	John Deere	Tier 4
125REOZJG	128/160	116/145	1800	John Deere	Tier 3
125REOZJ4	130/163	117/146	1800	John Deere	Tier 4
150REOZJF	154/193	140/175	1800	John Deere	Tier 3
150REOZJ4	154/193	139/174	1800	John Deere	Tier 4
180REOZJG	180/225	165/206	1800	John Deere	Tier 3
200REOZJF	200/250	180/225	1800	John Deere	Tier 3
230REOZJE	230/288	205/256	1800	John Deere	Tier 3
250REOZJE	255/319	230/288	1800	John Deere	Tier 3
275REOZJE	280/350	255/319	1800	John Deere	Tier 3
300REOZJ	300/375		1800	John Deere	Tier 3
350REOZJB	360/450		1800	John Deere	Tier 3
350REOZJ	350/438	320/400	1800	John Deere	Tier 3
400REOZJB	410/513		1800	John Deere	Tier 3
400REOZJ	400/500	365/456	1800	John Deere	Tier 3
500REOZJ	500/625		1800	John Deere	Tier 2
500REOZJB	510/638		1800	John Deere	Tier 2
500REOZVC	515/644	460/575	1800	Volvo	Tier 2
550REOZVB	550/688	500/625	1800	Volvo	Tier 2
600REOZVB	600/750	555/694	1800	Volvo	Tier 2
KD800	800/1000	720/900	1800	Kohler	Tier 2
KD900	900/1125	810/1012	1800	Kohler	Tier 2
KD1000	1000/1250	900/1125	1800	Kohler	Tier 2
KD1250	1250/1562	1120/1400	1800	Kohler	Tier 2
KD1500	1500/1875	1350/1687	1800	Kohler	Tier 2
KD1600	1600/2000	1440/1800	1800	Kohler	Tier 2
KD1750	1750/2187	1580/1975	1800	Kohler	Tier 2
KD2000	2000/2500	1820/2275	1800	Kohler	Tier 2
KD2250	2250/2812	2050/2563	1800	Kohler	Tier 2
KD2500	2500/3125	2270/2837	1800	Kohler	Tier 2
KD2800	2800/3500	2540/3175	1800	Kohler	Tier 2
KD3000	3000/3750	2720/3400	1800	Kohler	Tier 2
KD3250	3250/4063	2950/3688	1800	Kohler	Tier 2
KD3500	3500/4375	3180/3975	1800	Kohler	Tier 2
KD3800	3800/4750	3450/4312	1800	Kohler	Tier 2
KD4000	4000/5000	3630/4537	1800	Kohler	Tier 2

Stationary emergency ratings based on 3-phase, 480 V  
50-Hz non emissions models are also available. Please contact the factory  
Single-phase ratings also available  
For additional technical specifications, visit [KOHLEPOWER.com](http://KOHLEPOWER.com)





Go behind the scenes at **Aurora Memorial Medical Center**, one of America's Top 100 hospitals. And see why it chose KOHLER for its industrial power needs.

 [KohlerPower.com/Aurora](http://KohlerPower.com/Aurora)

MODEL	STANDBY 60 Hz (kW/kVA)	PRIME 60 Hz (kW/kVA)	RPM	Engine Manufacturer	EPA Emissions
700REOZDE	700/875	630/788	1800	MTU	Tier 2
750REOZMD	760/950	690/863	1800	Mitsubishi	Tier 2
800REOZDE	800/1000	725/906	1800	MTU	Tier 2
800REOZMD	810/1013	730/913	1800	Mitsubishi	Tier 2
800ROZMC	810/1013	730/913	1800	Mitsubishi	
900REOZDE	910/1138	830/1038	1800	MTU	Tier 2
900REOZMD	970/1213	915/1144	1800	Mitsubishi	Tier 2
1000REOZDE	1000/1250	910/1138	1800	MTU	Tier 2
1000REOZMD	1020/1275	925/1156	1800	Mitsubishi	Tier 2
1000ROZMC	1020/1275	925/1156	1800	Mitsubishi	
1250REOZDD	1300/1625	1180/1475	1800	MTU	Tier 2
1250ROZMC	1280/1600	1160/1450	1800	Mitsubishi	
1250REOZMD	1280/1600	1160/1450	1800	Mitsubishi	Tier 2
1500REOZDD	1560/1950	1400/1750	1800	MTU	Tier 2
1600ROZMC	1600/2000	1450/1813	1800	Mitsubishi	
1600REOZMD	1600/2000	1450/1813	1800	Mitsubishi	Tier 2
1750REOZDC	1760/2200	1600/2000	1800	MTU	Tier 2
1750REOZMD	1780/2225	1620/2025	1800	Mitsubishi	Tier 2
2000REOZDD	2060/2575	1850/2313	1800	MTU	Tier 2
2000ROZMC	2000/2500	1820/2275	1800	Mitsubishi	
2000REOZMD	2000/2500	1820/2275	1800	Mitsubishi	Tier 2
2250REOZDD	2250/2813	2050/2563	1800	MTU	Tier 2
2500REOZDB	2500/3125	2270/2838	1800	MTU	Tier 2
2800REOZDB	2800/3500	2540/3175	1800	MTU	Tier 2
3250REOZD	3250/4063	2800/3500	1800	MTU	Tier 2

# GAS GENERATORS

25–1300 kW

Custom made to meet your needs.



KG60



125REZGB



200REZXB

Good news: you can forget all that one-size-fits-all nonsense. KOHLER® gas generators are tailored and targeted to your specific job requirements. Unlike most generator models, every KOHLER generator is designed to work precisely for standby, prime or continuous applications. So you know you're getting the right power and the right power rating—and enjoying huge cost savings along the way.

But we didn't just stop there. We've also simplified the installation process—every model\* is available EPA-certified to meet operational requirements on pipeline natural gas. There's no need to certify or recertify.

## STANDARD FEATURES

### Tested and Approved

KOHLER generators meet tough industry testing and quality standards (UL, CSA, IBC, NFPA).

### One-Step Full-Load Acceptance

Our gas generators accept full load to keep you up and running.

### Ultimate Performance

Our 1800-rpm engines run quietly and efficiently to extend generator life and provide significant fuel savings.

### Factory-Certified Generators

Every size KOHLER gas generator is available EPA-certified\*, ECM-controlled and designed to meet the latest spark-ignited emission requirements.

### Versatile Power

KOHLER gas generators are made for more than just emergencies. You can also use them for standby, prime and continuous applications.



## 30CCL

### 1. SOUND ENCLOSURE\*

Durable aluminum sound-attenuating enclosure with optional windload

### 2. ALTERNATOR

Our wound field excitation system with its unique PowerBoost™ design delivers great voltage response and short-circuit capability

Brushless, rotating-field alternator has broad-range reconnectability

### 3. APM402 CONTROLLER

Provides advanced control, system monitoring and system diagnostics for optimum performance and compatibility

### 4. FUEL SYSTEM

Simple field conversion between natural gas and LPG fuels while maintaining emission certification

### 5. ENGINE FEATURES

Powerful and reliable 2.2L turbocharged liquid-cooled engine and electronic engine management system

### 6. INNOVATIVE COOLING SYSTEM

Electronically controlled fan speeds minimize generator set sound signature

Our new line of standby generators is specifically designed for industrial light commercial applications including small retail, commercial and municipal buildings, universities and apartment complexes.

### Runs Quietly and Efficiently

Sound-attenuated enclosure and new KOHLER 2.2L turbocharged engine keeps noise to a minimum.

### Industry Certified

Designed to meet NFPA 110 Level 1 requirements when equipped with required accessories and installed per NFPA 110 standards.

### Rust-Resistant

KOHLER Power Armor™ provides corrosion resistance in harsh conditions.

### 5-Year Warranty

Comes with a standard 5-year/2,000-hour warranty with optional extended warranty.

\*Sound level - log average @ 7m (23ft) at no load.



# GAS GENERATORS

MODEL	60 Hz (kW/kVA)					RPM	Emissions
	NG Standby	LP Standby	NG Prime	NG Continuous	LP Prime		
25CCL	25/31	25/31				1800	EPA-certified
30CCL	30/38	30/38				1800	EPA-certified
36CCL	36/45	36/45				1800	EPA-certified
KG40	40/50	40/50				1800	EPA-certified
KG45	45/56	45/56				1800	EPA-certified
KG50	53/66	53/66				1800	EPA-certified
KG60	60/75	60/75				1800	EPA-certified
80REZGD	80/100					1800	EPA-certified
100REZGD	100/125	100/125				1800	EPA-certified
125REZGC	128/160	106/133				1800	EPA-certified
150REZGC	150/188	139/174				1800	EPA-certified
180REZXB	190/238	130/163	164/205			1800	EPA-certified
180RZXB	190/238	130/163	164/205			1800	
200REZXB	200/250	130/163	175/219			1800	EPA-certified
200RZXB	200/250	130/163	174/219			1800	
250REZXB	260/325	170/213	235/294			1800	EPA-certified
250RZXB	260/325	175/219	235/294			1800	
300REZXB	300/375	210/263	270/338			1800	EPA-certified
300REZXC	300/375					1800	EPA-certified
300RZXB	300/375	210/263	270/338			1800	
350REZXB	355/444	240/300	300/375			1800	EPA-certified
350RZXB	355/444	240/300	300/375			1800	
400REZXB	400/500	260/325	360/450			1800	EPA-certified
400RZXB	400/500	260/325	360/450			1800	
500REZK	500/625		435/543			1800	EPA-certified
750REZK	750/937		630/787			1800	EPA-certified
1000REZK	1000/1250		880/1100			1800	EPA-certified
400REZCK				435		1800	EPA-certified
600REZCK				675		1800	EPA-certified
800REZCK				875		1800	EPA-certified
1000REZCK				1030		1800	EPA-certified
1300REZCK				1310		1800	EPA-compliant

Ratings based on 3-phase, 480 V. Continuous rating at power factor of 1.0  
 50-Hz nonemissions models and single-phase ratings are also available  
 For additional technical specifications, visit [KOHLERPOWER.com](http://KOHLERPOWER.com)

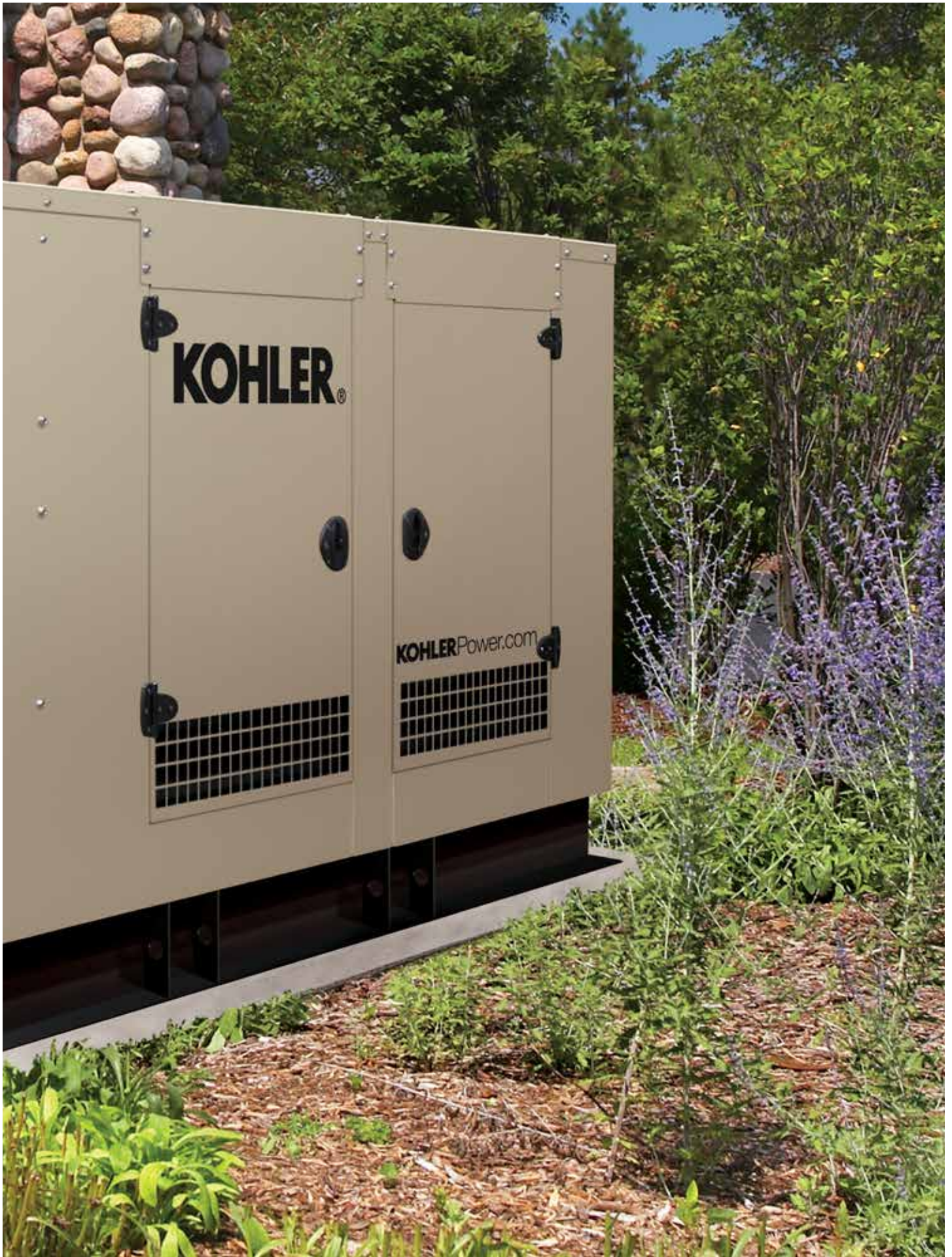



# KOHLER® FAST-RESPONSE® ALTERNATORS

## All the bells and whistles. No extra charge.

More than 90 years ago, Kohler unleashed its first alternator—and we've been raising the bar ever since. Today we're proud to manufacture KOHLER Fast-Response Permanent Magnet Generator (PMG) alternators—a breakthrough in speed technology. Built to perform, these revolutionary alternators offer fast response to load changes.

On some other gensets, PMG alternators come as a costly upgrade. Not so with Kohler. All of our 25- to 300-kW units are factory-equipped with our Fast-Response PMG alternators. Which means you get all the bells and whistles with no expensive upcharge.



### STANDARD FEATURES

#### Trusted Reliability

Greaseless bearing and Class H insulation provide extra thermal protection for lasting reliability.

#### Ultimate Performance

High-power density design makes Kohler an industry leader in motor-starting capability.

#### Tested and Approved

Our alternators meet NEMA MG 1, IEEE and ANSI standards for temperature rise and motor-starting capability.

#### Clean Power

Experience the rewards of clean power with precise voltage, current and frequency control.

#### Durable

#### Short-Circuit Ratings

The very definition of performance. Our alternators sustain short-circuit currents up to 300% of the rated current—for up to 10 seconds.

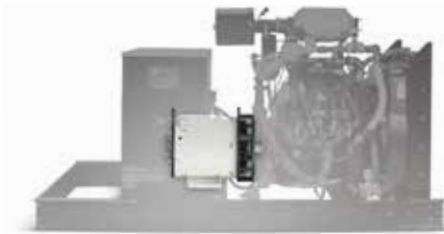
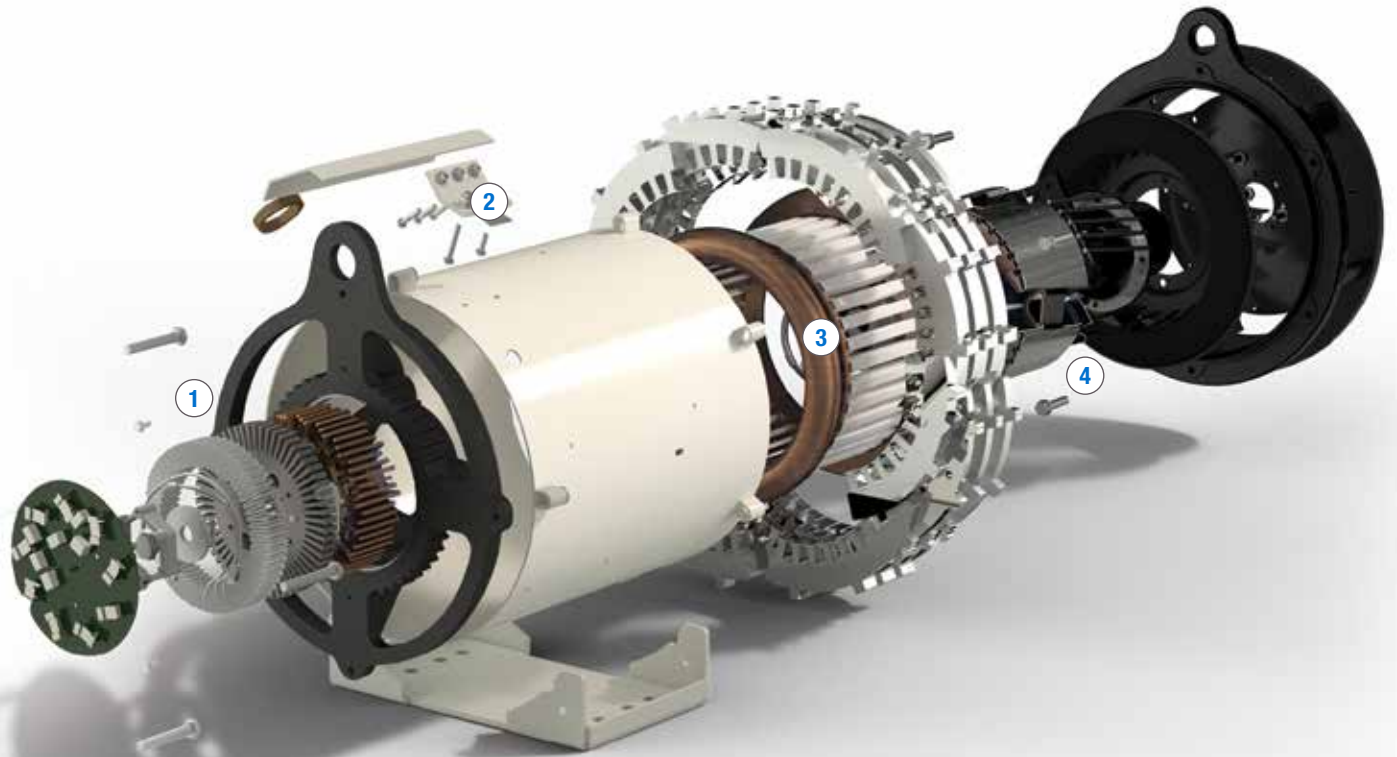

- 1. PMG-BRUSHLESS ALTERNATOR**  
*Features brushless permanent magnet exciter for fast load response*
- 2. RECONNECTABLE LEADS**  
*Designed with 4-lead dedicated voltages and 12-lead optional voltage connections*
- 3. VACUUM-IMPREGNATED WINDINGS**  
*Fungus-resistant epoxy varnish ensures reliability in tough environments*
- 4. ROTOR**  
*Two-thirds-pitch stator and skewed rotor deliver clean power and superior voltage waveform*

# KOHLER® DECISION-MAKER® CONTROLS

Technology so advanced, it's easy.

At Kohler, we don't do one size fits all. With our Decision-Maker controls, we design custom packages, tailored to your needs—from basic controls to multiple generator paralleling.

Plus, Kohler makes each controller easy to operate with user-friendly displays and keypad functions. And if that weren't enough, our complete line of Decision-Maker controllers features advanced network communications for remote monitoring as well as adjustable parameters to accommodate your specific application.

## STANDARD FEATURES

### **Tested and Approved**

Our controls meet NFPA, UL and CE standards.

### **Integral Voltage Regulator**

KOHLER controls deliver precise voltage regulation (.25%–.50%) to protect your sensitive equipment from poor power quality.

### **Seamless System Integration**

Every controller works with our automatic transfer switches and switchgear for complete system integration

### **Alternator Protection**

This must-have technology protects the alternator from thermal overload.



*Remote Annunciator*



Decision-Maker 6000

## REMOTE COMMUNICATIONS

### Monitor Software

Monitors and controls generator sets and transfer switches from your personal computer.

### PowerScan™

Provides system monitoring around the clock using wireless technology to send messages to your phone, fax and email.

### Remote Annunciator

Offers an economical solution for remote annunciation of faults and status conditions for NFPA-110 compliance.

1. **EMERGENCY STOP BUTTON**  
*Turns off generator immediately*
2. **CONTROL BUTTONS**  
*Control synchronizing breakers and generator operation (Off/Auto/Run)*
3. **STATUS INDICATORS**  
*Display generator mode, breaker and synchronization status*
4. **DIGITAL ALPHA/ NUMERIC DISPLAY**  
*Displays faults, warnings, codes and metering*
5. **KEY SWITCH**  
*Secures your program settings*
6. **PUSH-BUTTON KEYPAD**  
*Sets custom parameters, displays menus, resets faults and more*

# KOHLER® DECISION-MAKER® CONTROLS



3000



550



6000

## COMMON FEATURES

### Inputs and Outputs

All models include digital and analog input and output with option for additional inputs/outputs

### Engine Status and Condition Indicators

- Oil pressure/temperature
- Coolant temperature
- Engine speed
- Number of starts
- Battery voltage

### Alternator Status and Condition

- Voltage, L-L and L-N for all phases
- Current/frequency for all phases
- Total kW/kVA and KVAR
- kWh
- Power factor\*
- Per phase kW/kVA and KVAR\*

### Engine Protection–Shutdown/Indication

- High engine coolant temperature
- Low coolant level
- Low oil pressure
- Overcrank
- High/low fuel level/pressure
- Overspeed
- Load-shed output\*,‡

### Alternator Protection–Shutdown/Indication

- Over- and under-voltage/frequency
- Overcurrent
- Overpower
- Locked rotor†,‡
- Reverse power/VAR\*

\*Except Decision-Maker 3000.

†Except Decision-Maker 8000

‡Except APM802





8000



APM802



3500 - available on mobile generators only

Decision-Maker Model	3000	550	6000	8000	APM802	3500
<b>Integral voltage regulator</b>	x	x	x			x
<b>Engine diagnostics</b>	x	x	x	x	x	x
<b>Engine starting aid</b>	x	x	x			x
<b>Event and data logging</b>	x	x	x	x	x	x
<b>Programming access via laptop</b>	x	x	x	x	x	x
<b>Key switch</b>		x	x			
<b>USER INTERFACE</b>						
<b>Alphanumeric digital display</b>	x	x	x			
<b>Monochromatic graphical display</b>						x
<b>Color graphical display</b>				x	x	
<b>Emergency stop (remote)</b>	x	x	x	x	x	x
<b>Exercise function</b>		x	x			x
<b>COMMUNICATIONS</b>						
<b>Local and remote area network capability</b>	x	x	x	x	x	x
<b>Monitoring software</b>	o	o	o	x	x	
<b>PARALLELING</b>						
<b>Remote input for external paralleling controller</b>		x		x	x	x
<b>Dead-bus paralleling</b>			x	x		x
<b>Dead-field paralleling</b>				x		
<b>Synchronizer</b>			x	x		x
<b>Real and reactive load sharing</b>			x	x		x
<b>First-on logic</b>			x	x		x
<b>Circuit breaker control</b>			x	x		x
<b>Base load control</b>			x	x		x
<b>Var/power factor control</b>			x	x		x
<b>Load management</b>			o	x		x
<b>Generator management</b>			o	x		x

KEY: STANDARD = x / OPTION = o

# ENCLOSURES

Reduce the racket. And put Mother Nature in her place.

If you want to keep the weather out and the noise in, there's really only one way to go. KOHLER® enclosures are bolstered by industrial steel or heavy-duty aluminum and acoustic insulation to protect your investment and keep the noise down. In addition, we coat every unit with Power Armor™ (a textured industrial finish) for heavy-duty durability in harsh conditions. UL 2200-listed and IBC-certified packages are available.

## STANDARD FEATURES

### Custom Options

Multiple weather/sound enclosure options are available on 15 to 4000-kW generators.

### Quiet Performance

Our enclosures offer acoustic insulation to meet your quiet applications.

### Certified Packages

Enclosures are UL 2200-listed, IBC-certified and meet up to 181-mph wind rating.

### Advanced Corrosion Protection

Power Armor is a textured automotive-grade finish that surpasses a 3500-hour salt spray exposure test.

1. **ADVANCED DOOR SYSTEM**  
*Hinged doors, door handles and door holders provide security, protection and easy access for service*
2. **SERVICE ACCESS**  
*Multiple personnel doors and removable panels offer easy access to generator control, fuel fill, fuel gauge, oil fill and battery*
3. **INTERNAL EXHAUST SYSTEM**  
*Features insulated exhaust silencer for improved aesthetics, safety and noise reduction*
4. **OIL AND RADIATOR DRAINS**  
*Provide an easier, quicker way to service your generator*
5. **AVAILABLE ACCESSORIES**  
*Electrical packages, lighting, heaters, motorized louvers, stairs and more*



400REOZJ



80REZGD

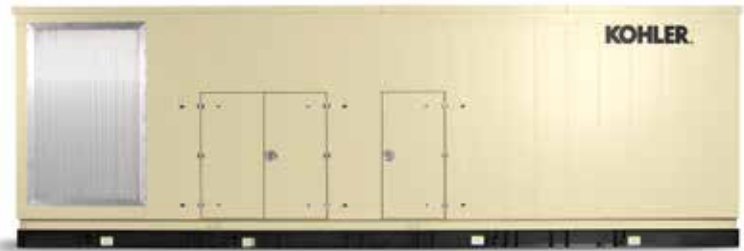

KD1750

Sound Levels			
KW	Engine Manufacturer	Weather Enclosure dBA	Sound Enclosure dBA
15-60 kW	Kohler	77-80	64-65
25-150 kW	GM	75-85	65-73
80-300 kW	John Deere	80-94	68-75
350-500 kW	John Deere	90-94	73-75
500-600 kW	Volvo	94-95	75
700-1000 kW	Kohler/MTU	93-98	75
1250-4000 kW	Kohler/MTU/Mitsubishi	85-101	75-85

Sound level full-load dBA @ 23 feet

# SUB-BASE FUEL TANKS

Made to match your environmental needs.

If it's environmental protection you want, you're in the right place. KOHLER® tanks feature two containment walls to keep your fuel where it should be—inside. Plus, they're coated with Power Armor Plus™ (a textured epoxy-based, rubberized finish) for heavy-duty durability.

## STANDARD FEATURES

### Environmental Protection

Our tanks are UL-listed secondary containment tanks and can be configured to meet cUL, IBC and other required codes.

### Multiple Runtimes

Usable tank capacities provide up to 96 hours of operation.

### Custom Options

Choose from alarm panels, spill-fill containments, high-fuel switches, tank markings and more.

### Excellent Protection

Our new Power Armor Plus polyurea textured coating eliminates the need for exterior epoxy treatment and provides excellent abrasion resistance and corrosion protection.

- 1. STATE TANK OPTIONS**  
*Spill-fill containments, three-alarm panel, fuel basin switch and tank markings*
- 2. EMERGENCY PRESSURE-RELIEF VENTS**  
*Ensure proper venting of inner and outer tank during extreme conditions*
- 3. NORMAL VENT WITH CAP**  
*Raised above the lockable fuel fill cap*
- 4. ELECTRICAL STUB-UP**  
*Features large stub-up area for easy installation*
- 5. LEAK DETECTION SWITCH**  
*Annunciates a contained primary tank fuel leak at generator control*
- 6. FUEL SWITCH**  
*Interfaces with controller to provide fuel level indication*



Sub-Base Fuel Tank



# MOBILE GENERATORS

35–175 kW

## Take your power to go.

Quiet, reliable KOHLER® mobile generators give you dependable power anywhere, from remote construction sites to public events to storm recovery. Tough to the core, they're built to withstand the elements and run for long hours in prime and standby applications. Upgrade your rental fleet with hard-working mobile units. They're loaded with features for power that work wherever you go.

- 1. LIFTING EYE**  
*Convenient single-point lifting eye*
- 2. KOHLER DECISION-MAKER. 3500 CONTROLLER**  
*User-friendly LCD display and advanced network communications*
- 3. REMOVABLE HOUSING**  
*Patented housing is easy to remove—just unscrew bolts from the base\**
- 4. ONBOARD FUEL TANK**  
*24-hour runtime tanks are standard on diesel models, optional on gaseous models*
- 5. RUGGED TRAILER**  
*Tough commercial trailer with electric braking system*
- 6. TWO-WAY FUEL VALVE**  
*Easily switches among onboard LP, external LP or natural gas fuel (gaseous model); switches between onboard and external fuel tank draw (optional on diesel models)\**







# MOBILE GENERATORS

## STANDARD FEATURES

### DIESEL MOBILE GENERATORS

#### Easy on the Environment

EPA-emission-certified for nonroad use with 110% containment of fuel, oil and coolant. Tier 4 Final engines with lower operating costs\* give you heavy-duty power for any demanding application.

#### Engines For The Future

KOHLER® Diesel KDI engines have no DPF (diesel particulate filter) for a smaller overall footprint without DPF maintenance. Cooled exhaust gas recirculation (EGR) helps achieve the industry's toughest emissions standards. Ultraefficient performance provides savings. John Deere engines have Integrated Emissions Control systems—cooled EGR, exhaust filter and SCR—that result in high power density, high torque and lower fuel consumption.

### GASEOUS MOBILE GENERATORS

#### Innovative Propane Tank System

LP gas is reliable, readily available, refills just like diesel and produces less smog-producing carbon monoxide. Easily switch to natural gas or external propane for extended power supply.

#### Lower Operating Costs

KOHLER mobile generators with propane engines offer a 15%-20% reduction in hourly fuel costs.†

### GENERATOR PARALLELING BOX

The KOHLER Mobile Paralleling Box provides the flexibility to parallel any Tier 4 Final or gaseous KOHLER mobile generators to meet job requirements—without the need for expensive motorized breakers. And thanks to the paralleling intelligence built into the DEC3500 controller, each box can parallel two generators. Up to four paralleling boxes and eight generator sets can be connected to one distribution bus.



*Mobile Paralleling Box*



Take a trip to America's heartland, where KOHLER power systems are actively protecting the lives of thousands of families across Iowa at the **Rathbun Regional Water Association**.

📺 [KohlerPower.com/Rathbun](https://www.kohlerpower.com/Rathbun)

Model	Standby 60 Hz (kW/kVA)	Prime 60 Hz (kW/kVA)	Fuel	EPA Emissions
35REOZT4	30/37.5	28/35	Diesel	Tier 4F
45REOZT4	40/50	36/45	Diesel	Tier 4F
55REOZT4	48/60	43/53	Diesel	Tier 4F
90REOZT4	85/106	76/95	Diesel	Tier 4F
120REOZT4	105/131	96/120	Diesel	Tier 4F
145REOZT4	130/163	117/146	Diesel	Tier 4F
175REOZT4	154/193	139/174	Diesel	Tier 4F
70REZGT	62/77	56/70	LP/NG	EPA-certified
125REZGT	105/131	95/119	LP/NG	EPA-certified



“

**FROM OUR  
EXPERIENCE,  
KOHLER IS THE**

***BEST OUT***

***THERE***

**ROD WITT**, maintenance supervisor  
Rathbun Regional Water Association

”

# AUTOMATIC TRANSFER SWITCHES

They protect your power. And your business.

KOHLER® advanced transfer switches—featuring ATS controllers—are loaded with technology to ensure transfer of power from the utility to the generator and back. When the grid fails, power is transferred to the standby system. And then it's back to business as usual.

## STANDARD FEATURES

### Multiple Applications

Find the perfect option. KOHLER transfer switches are available in standard, bypass-isolation and service-entrance configurations with open, closed and programmed transition operating modes, from 30 to 4000 amps.

### Seamless System Integration

Everything works together. KOHLER transfer switches are designed to interface perfectly with KOHLER generators and paralleling switchgear.

### Advanced Communications

Every transfer switch comes fully loaded with the technology to do the job. Ethernet and Modbus communications capabilities are available.

### Certified Packages

Transfer switches are UL-listed and have CSA and IBC certifications available.

1. **CERTIFIED ENCLOSURES**  
*Meet NEMA Type 1, 3R, 12, 4 and 4X enclosure standards*
2. **BYPASS OPERATION**  
*Eliminates interruption to the loads during maintenance*
3. **DECISION-MAKER® CONTROLLER**  
*Provides a full array of features including communications, I/O, load management and other advanced functionality*
4. **HEAVY-DUTY CONTACTOR**  
*Choose from any breaker, specific breaker or current limiting fuse-rated mechanisms*
5. **AVAILABLE ACCESSORIES**  
*Anticondensation heater, voltage-surge suppressor, line-to-neutral voltage monitoring, seismic certification and more*



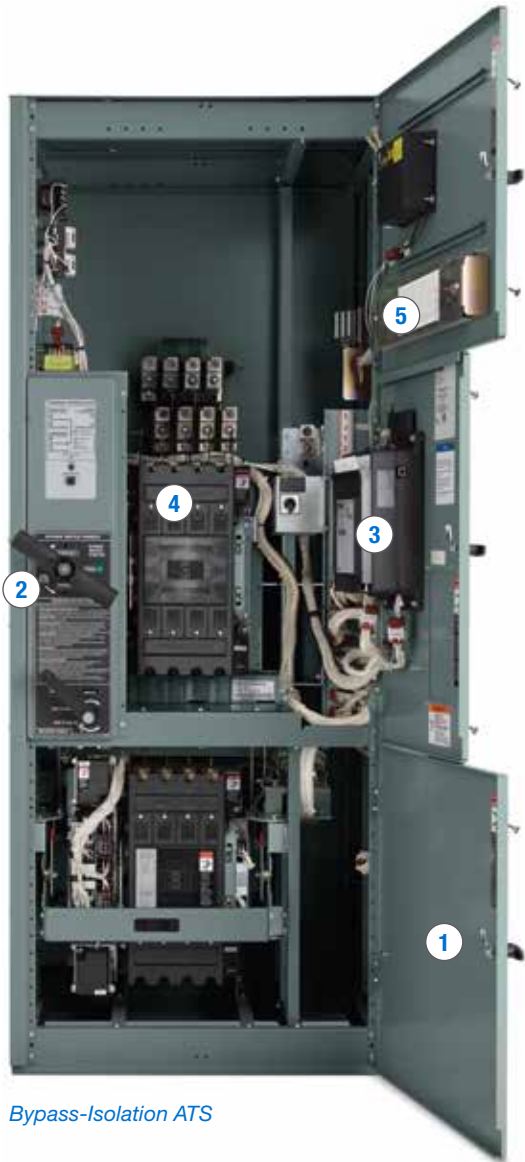

*Bypass-Isolation ATS*



*Service-Entrance ATS*



*Standard ATS*

# DECISION-MAKER® AUTOMATIC TRANSFER SWITCH CONTROLLERS

The controller is the brain behind your automatic transfer switch. It tells the switch what to do and when, dictating the logic that determines the reaction.



## ATS750

Control critical system settings with a no-frills controller that gets the job done. Set time delays, create a system exercise and transfer loads as required.



## ATS1200

A customizable solution for your specific application. The ATS1200 gives you full control of system behavior including extended I/O to customize your needs.



## ATS1500

When you need to manage your loads, use your system as a prime power application or have a backup for your backup (i.e., a three-source system); this controller gets the job done.

DECISION-MAKER	ATS750	ATS1200	ATS1500
<b>Amperage</b>	Up to 1000 A	Up to 4000 A	Up to 4000 A
<b>Phases</b>	Single/Three	Single/Three	Single/Three
<b>Poles</b>	2, 3, 4	2, 3, 4	2, 3, 4
<b>Voltage range</b>	115-480 V	115-600 V	115-600 V
<b>Product Type</b>			
<b>Standard open transition</b>	Yes	Yes	Yes
<b>Standard delayed transition</b>		Yes	Yes
<b>Standard closed transition</b>		Yes	Yes
<b>Bypass-isolation open transition</b>			Yes
<b>Bypass-isolation delayed transition</b>			Yes
<b>Bypass-isolation closed transition</b>			Yes
<b>Service entrance</b>			Yes
<b>Withstand and Close-On Ratings (WCR)</b>			
<b>WCR-Specific breaker</b>	30-65 kA	30-65 kA	22-100 kA
<b>WCR-Any breaker</b>		10-100 kA	10-100 kA
<b>WCR-Current-limiting fuses</b>		100-200 kA	100-200 kA
<b>Short-time withstand rating</b>		36-65 kA	36-65 kA



DECISION-MAKER	ATS750	ATS1200	ATS1500
<b>User Interface</b>			
LED–Contactor position / source available	Standard	Standard	Standard
LED–Service required (fault indication)	Standard	Standard	Standard
LED–Not in automatic mode	Standard	Standard	Standard
Display		LCD	LCD
Programming	USB	USB, Display	USB, Display
<b>Voltage and Frequency Settings</b>			
Pickup / Dropout normal source voltage	Programmable	Programmable	Programmable
Pickup / Dropout emergency source voltage		Programmable	Programmable
Frequency selection	50/60 Hz	50/60 Hz	50/60 Hz
Pickup / Dropout normal source frequency			Programmable
Pickup / Dropout emergency source frequency		Programmable	Programmable
Overvoltage trip		Programmable	Programmable
Overfrequency trip		Programmable	Programmable
Normal and emergency voltage unbalance		Standard	Standard
Inphase monitor	Standard	Standard	Standard
Transfer commit		Standard	Standard
Phase rotation sensing		Standard	Standard
<b>Time Delays and Configuration Settings</b>			
Transfer to emergency / Transfer to normal	Programmable	Programmable	Programmable
Engine cooldown	Fixed	Programmable	Programmable
Generator exerciser	7-Day	21 exercise events	21 exercise events
Remote peak shave		Standard	Standard
Start-time delay	Programmable (emergency only)	Programmable (emergency only)	Programmable
Fail to acquire	Programmable (emergency only)	Programmable (emergency only)	Programmable
<b>Communications</b>			
RS-485	Standard	Standard	Standard
Ethernet	Optional	Optional	Standard
<b>Accessories</b>			
Programmable engine exerciser	Optional external device	Standard	Standard
Extended I/O		Optional (Up to 4 modules)	Optional (Up to 4 modules)
Digital meter		Optional	Optional
Source priority selector		Optional	Optional
Extended engine start-time delay		Optional	Optional
Controller disconnect switch	Optional	Optional	Optional
Load shed		Optional	Optional
Load control		Time-based	Time- or current-based
Three-source system			Standard
Prime power			Standard

# PARALLELING SWITCHGEAR

## Load it up. Any way you want.

Whether your needs are for emergency, prime power, interruptible rate or peak shaving applications, Kohler has the switchgear to back them all up. When it's time to spec, our team will take care of you every step of the way—from concept to startup. And we will engineer custom switchgear to meet your needs.

### STANDARD FEATURES

#### Custom Design

Tailor-made from top to bottom. Our switchgear is engineered to specifically meet your unique application.

#### Certified Packages

All KOHLER® switchgear is cUL-listed. IBC and OSHPD certification is available.

#### Seamless System Integration

It's simple really. Our switchgear works with the entire KOHLER power system—generators, automatic transfer switches and more.

#### Design Support

Need help? Our experts are ready to assist in switchgear design.

1. **CIRCUIT BREAKERS**  
Choose from a variety of paralleling and distribution circuit breakers
2. **CUSTOM OPTIONS**  
Choose from controls, meters, protective relays and more
3. **CONTROL CENTER**  
Features color touch screen, USB port for downloading reports, Modbus communications, Web server and more
4. **LOW AND MEDIUM VOLTAGES**  
Available up to 13.8 kV





## KOHLER PD-SERIES

Now when it comes to flexibility in generator paralleling, KOHLER PD-Series paralleling switchgear is the way to go. If utility power ever fluctuates or fails, your KOHLER switchgear automatically reacts to the situation, engages the generators and connects them to your facility.

Features	PD-2000	PD-3000	PD-4000
Low-voltage switchboard (UL/cUL 891)	x		
Low-voltage switchgear (UL/cUL 1558)		x	
Medium-voltage metal-clad switchgear (UL/cUL-listed)			x
NEMA 1	x	x	x
NEMA 3R	x	x	x
Short-circuit rating up to 200 kA		x	x
Short-circuit rating up to 150 kA	x		
Bus rating up to 10,000 A	x		
Bus rating up to 9200 A		x	
Bus rating up to 6000 A			x
Maximum voltage 600 V	x	x	
Maximum voltage 15 kV			x
60 Hz	x	x	x
50 Hz	x	x	x
Parallel up to 32 generators	x	x	x
15" color touch screen (optional touch screen sizes available)	x	x	x
Customizable controls, relays and metering	x	x	x
Modes of Operation			
Emergency standby	x	x	x
Prime power	x	x	x
Base load (peak shave)	x	x	x
Import (peak shave)	x	x	x
Isolate (interruptible rate)	x	x	x
Customizable sequence of operation	x	x	x

# DECISION-MAKER® PARALLELING SYSTEM

Total integration. From top to bottom.

When it comes to paralleling systems, Kohler offers 100% integration. Our Decision-Maker Paralleling System (DPS) is designed, engineered and factory-tested as a complete system, unlike other paralleling products built from a variety of components from numerous manufacturers.

Comprised of KOHLER® generators, controls and switchboards, DPS delivers dependable power across multiple applications.

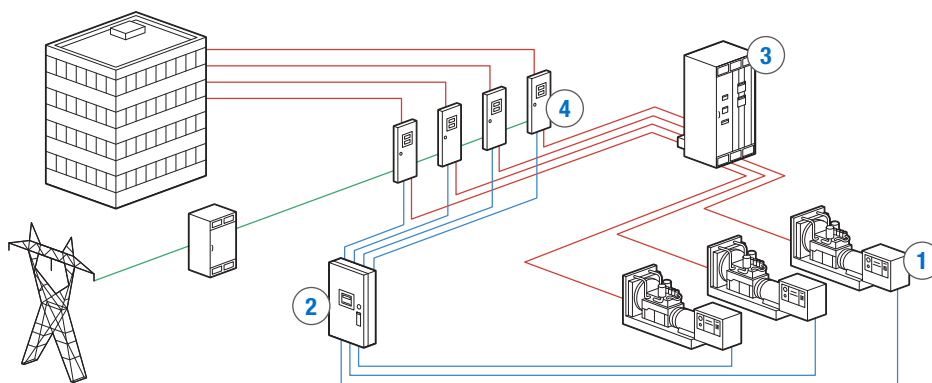

- 1. KOHLER DECISION-MAKER 6000 CONTROLLER**  
*Enables load sharing and synchronization for up to eight generator sets in the KOHLER DPS*
- 2. MASTER CONTROL PANEL**  
*Handles load add/shed, number of gensets online, monitors event logging and alarms*
- 3. POWER DISTRIBUTION SWITCHBOARD**  
*Accommodates paralleling and distribution breakers*
- 4. AUTOMATIC TRANSFER SWITCH**  
*Intelligently selects the power source and transfers loads*





## STANDARD FEATURES

### **Redundant Backup Power**

Total and complete protection. If one genset needs servicing, the DPS makes power available to your most critical loads.

### **Easy Expansion**

Purchase a system that fits your budget today. And, in the future, we'll expand on your DPS instead of completely replacing it.

### **Operational Savings**

Saving has never been easier. The DPS automatically turns off generators when your needs are low.

### **Fast Lead Times**

Our DPS is a standard product, no customization necessary. So you'll get it faster than custom paralleling systems.

### **Optional Fuel Types**

Mix and match any generator fuel types you want. Available for use with diesel, natural gas and LP fuel types in the same system.





# POWER SOLUTIONS CENTER

## Sizing and specifying has never been easier.



Introducing Power Solutions Center from Kohler. An intuitive spec and sizing program that does the work for you—including drag-and-drop load management, automatic one-line diagrams and accurate specs. Plus sizing for pipes, exhaust and fuel lines. It's the easiest, most comprehensive specifying tool you'll ever use. Available now on your PC and Apple® and Android tablets.

Download it free at [KohlerPower.com/PSC](http://KohlerPower.com/PSC).

## STANDARD FEATURES

### Quick Drag-and-Drop Load Management

- Build system with generators, transfer switches and transformers
- Duplicate or delete loads with a click of the mouse
- Automatically calculate harmonic load analysis

### Automatic One-Line Diagram and Steps Report

- Instantly display and print easy-to-read diagrams
- See parameters that fall outside specified limits

### Prepopulated Engineering Tools

- Get tools for exhaust, fuel line and room sizing in seconds
- Add lighting, air conditioning, elevators and other equipment

### Optimum Generator Set Results

- Review a selection of generator set options
- Display generator performance details

### Summaries, Reports and Technical Documents

- Display or print diagrams and detailed sizing reports
- Download spec sheets, diagrams and BIM models instantly

### Quick, Hassle-Free Estimates and Information

- Click to connect with your KOHLER distributor

### Secure File Storage

- Store files on your local computer
- Share files online or by email
- Works whether you're online or offline

# THE BEST WAY TO PROTECT YOUR POWER.

## And Protect Your Team.

KOHLER® genuine parts are easily accessible, which can reduce customer downtime, improve your responsiveness and provide a competitive advantage. Structured to help you deliver top-tier service and capture profits, our Aftermarket Parts and Service team provides the parts, people and performance you can count on.

### PARTS

Designed to perform under the toughest environmental conditions, KOHLER genuine parts are built specifically for your generator—and will be available when you need them. They undergo extensive lab and field testing as part of the overall power system to ensure everything works as expected.

- Global sourcing
- Warehousing capabilities
- Enhanced genuine parts portfolio
- Online parts catalog
- Parts technical publications

### PEOPLE

Our experienced Aftermarket Parts and Service team is available to answer your questions. Choosing genuine parts provides you with comprehensive support, training and technical assistance straight from the factory.

- Factory training
- On-site technical support
- One point of contact for all your parts and service needs
- Dedicated aftermarket channel support

### PERFORMANCE

We continuously invest in better processes that make your job easier, and we're here to support you in decisions that affect your business.

- Inventory management
- Warranty management
- Lead-time strategy
- Information technology tools

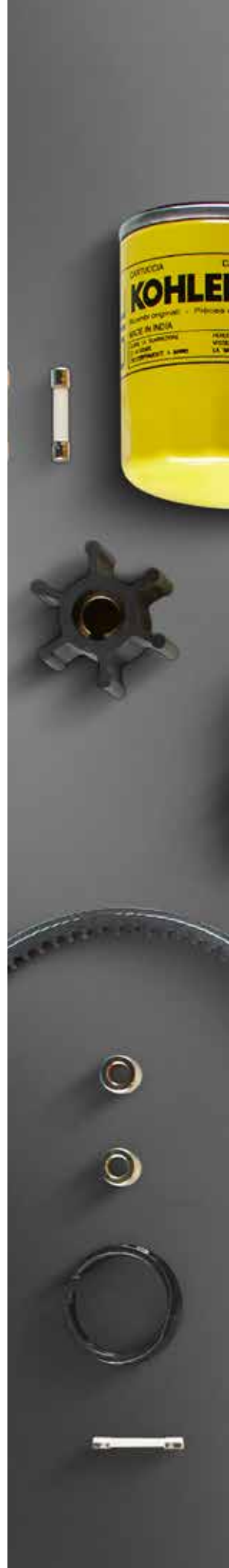

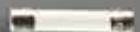



# SERVICE AND SUPPORT

## The help you need. Any time, anywhere.

You're never too far from Kohler. Across the world, more than 800 locations are ready to provide sales, installation and aftermarket support services. And each one offers expertise in power specifications, equipment and integration. There's no question they can't answer. We should know, we trained them ourselves.

Plus, if you ever need assistance in the middle of the night, we'll take care of you. Kohler Power professionals are available to offer troubleshooting, advice, service and support.





## **KOHLER® AND SDMO®: OUR STORY**

A global force in power solutions since 1920, Kohler is committed to reliable, intelligent products, advanced engineering and responsive after-sale support.

And you can find us on nearly every continent on the planet. Over the years we've amplified our global reach—acquiring SDMO Industries, an international leader known for its premium range of generator sets.

**Together we've built on the legacy of two leading brands to create one of the largest global manufacturers of generators—and continued an unwavering focus on reliable power systems and innovation.**

Our R&D, manufacturing, sales, service and distribution facilities span the globe from Kohler, Wisconsin, to Brest, France. And while we've maintained two world-renowned brand names, today Kohler and SDMO operate as an integrated global organization that's leading the way in design and manufacturing.

We deliver integrated industrial power systems for emergency, prime and continuous applications worldwide—from data centers and hospitals to water treatment facilities and government offices. With a deep understanding of your industry, we excel in designing customized power systems that simplify your most complex challenges.



**KOHLER**<sup>®</sup>  
IN POWER. SINCE 1920.

**North America** 800.544.2444

**KOHLERPOWER.COM**

PRINTED IN U.S.A. G12-18 7/18 © 2018 BY KOHLER CO.